

RESI[®]
www.resi.cz





JORDAN[®]
TRADITIONAL COUCH BRAND



Table of contents

page

JORDAN physiotherapeutic couch A line

 JORDAN A1	 JORDAN A3	 JORDAN A wood	4/5
---	---	---	-----

JORDAN physiotherapeutic couch D line

 JORDAN D1	 JORDAN D2	6/7
---	---	-----

JORDAN physiotherapeutic couch F line

 JORDAN F2	 JORDAN F3	 JORDAN F4	8/9
---	---	---	-----

JORDAN physiotherapeutic couch G line

 JORDAN G5	 JORDAN G6 plus	10/11
---	--	-------

JORDAN physiotherapeutic couch E line

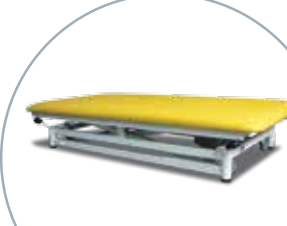
 JORDAN E1	 JORDAN E1 LOW	12/13
---	---	-------



14/15

JORDAN transfusion couch



16/17

JORDAN gynecologic couch H line



18/19

JORDAN wood



20/21

Optional accessories for JORDAN couches

22

Colours chart for JORDAN couches

23

JORDAN physiotherapeutic couch, A line

JORDAN A line – actuator-free couches with fixed height.

All model of this line are made at a standard height of 60 cm, but you may change this fixed height in your purchase order. Simple but solid structure guarantees high stability. Leveling screws can compensate for floor unevenness. The headrest can be adjusted either by a system of A1 levers or by an A3.

It is one of the most simply constructed couches on the market.. It has a broad field of application as an examination table in medical practitioner and specialist doctor surgeries, as massage tables or relaxation couches in spas, welfare institutions and sport centres.

JORDAN
A1

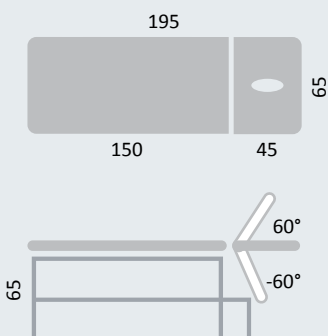
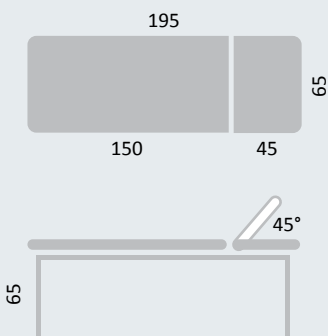

JORDAN
A3





natural version

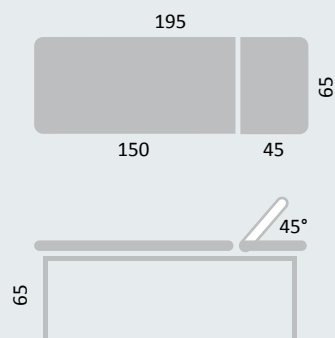

mahogany version with shelf



TECHNICAL PARAMETERS

Basic design of the JORDAN A line of couches	A1	A3	A wood
Cat. no.	1001.100	1001.030	1001.095
dimensions, length x width (cm)	195 x 65	195 x 65	195 x 65
fixed height, alteration at no extra charge (cm)	60	60	65
number of cushioned segments	2	2	2
mouth opening in bolster with cover	•	yes	-
head end adjustable by Rostomat system	yes	-	yes
head end adjustable by gas strut	-	yes	-
optional location of head part (by wall or vice-versa)	-	-	-
price	290 €	350 €	590 €

• extra orders possible - not available

OPTIONAL ACCESSORIES:

Cat. no.	name	A1	A3	A wood	price
1901.011	mouth opening in bolster with cover	•	x	-	50 €
1901.040	storage shelf	•	•	•	100 €

x basic design • extra orders possible - not available

JORDAN physiotherapeutic couch, D line

JORDAN D line – actuator-free couches with manual height adjustment using a lever mechanism.

The height of all the models can be adjusted manually using a built-in lever by the patient's feet. The adjustment range is from 65 to 85 cm. Base width of 100 cm for model D1 can be changed on request at no extra cost in the range of 70 to 100 cm.

JORDAN
D1

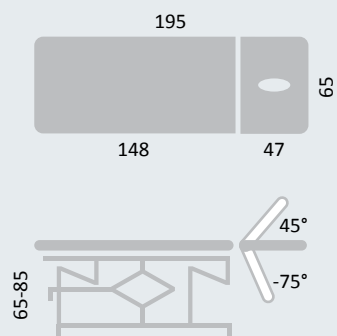
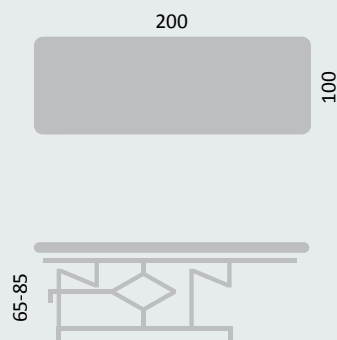

JORDAN
D2



These couches are recommended in particular for places where the service staff rotates, for example different massagers working with the same bed. This bed can be adjusted to individual height. Depending on your needs you may choose from three basic models as well as from a number of accessories.

This line is recommended for massages in spas, physiotherapy or sport centres, where it is used by more than one massager.



lever mechanism



castors – diameter 100 mm



conical narrowing



3-part head bolster

TECHNICAL PARAMETERS

Basic design of the JORDAN D line of couches	D1	D2
Cat. no.	1004.010	1004.020
dimensions, length x width (cm)	195 x 70 - 100 as required	195 x 65
manually adjustable height (cm)	65 - 85	65 - 85
number of cushioned segments	1	2
mouth opening in bolster with cover	•	yes
head end adjustable by gas strut	-	yes
leg position adjustable by gas strut	-	•
price	650 €	700 €

• extra orders possible - not available

OPTIONAL ACCESSORIES:

Cat. no.	name	D1	D2	price
1901.001	castors - diameter 70 mm	•	•	100 €
1901.002	castors - diameter 100 mm	•	•	160 €
1901.011	mouth opening with cover	•	x	30 €
1901.013	extended bed width over 80 cm inclusive	x	•	100 €
1901.014	sanitary paper holder	•	•	45 €

x basic design • extra orders possible - not available

JORDAN physiotherapeutic couch, F line

JORDAN F line - single-actuator couches with a stable construction and electrically adjustable height.

The F line offers the basic model of a professional couch in a new elegant design. The structure is stable in all therapeutic positions and heights with a lifting range from 50 to 105 cm with a patient lying on the couch. The lower position enables disabled and older people easy access to the couch.. The couch positions can be easily and quietly adjusted during therapy. This product line has a broad area of application.

Beds can be used for examinations, massages, physiotherapy. In addition, they can be used for simple surgical procedures. You can customize your bed to meet your needs by selecting from a broad portfolio of accessories.



TECHNICAL PARAMETERS

Basic design of the JORDAN F line of couches	F2e	F3e	F4e
Cat. no.	1006.021	1006.031	1006.041
dimensions, length x width (cm)	200 x 65	200 x 65	200 x 65
number of cushioned segments	2	3	4
3-part head bolster	-	-	yes
mouth opening in bolster with cover	yes	yes	yes
head end adjustable by gas strut	yes	yes	yes
leg position adjustable by gas strut	-	yes	-
electric height adjustment (cm)	50 - 105	50 - 105	50 - 105
manually adjustable height	yes	yes	yes
price	1.150 €	1.230 €	1.270 €



JORDAN
F3e

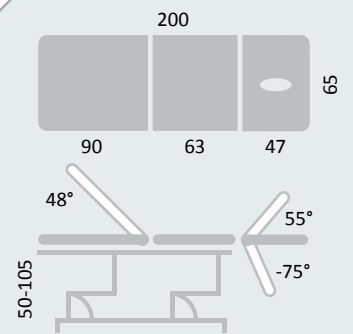

JORDAN
F4e

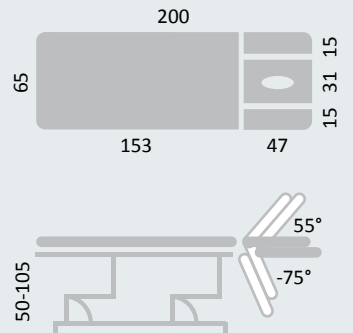

OPTIONAL ACCESSORIES:

Cat. no.	name	F2e	F3e	F4e	price
1901.001	castors - diameter 70 mm	•	•	•	100 €
1901.002	castors - diameter 100 mm	•	•	•	160 €
1901.006	conical narrowing at the foot end	•	•	•	50 €
1901.007	conical narrowing at the head end	•	•	•	50 €
1901.008	electric foot control unit	•	•	•	100 €
1901.009	RAL electric built-in control unit	•	•	•	100 €
1901.010	chrome electric built-in control unit	•	•	•	160 €
1901.013	extended bed width over 80 cm inclusive	•	•	•	50 €
1901.014	sanitary paper holder behind head end	•	•	•	50 €
1901.018	additional folding rests along the central part of the couch	•	•	•	120 €
1901.050	safety switch-off cabinet	•	•	•	100 €

• extra orders possible - not available

JORDAN physiotherapeutic couch, G line

JORDAN G line – double-actuator couches of stable construction whose height can be adjusted and backrest altered to the drainage position electrically.

The G line offers a higher standard of professional couches with an elegant design. The construction is stable in all therapeutic positions and heights with a lifting range from 50 to 105 cm even with the patient lying on the couch. The lower position enables disabled and older people easy access to the couch.



TECHNICAL PARAMETERS

Basic design of the JORDAN G line of couches	G5e	G6 plus
Cat. no.	1007.051	1007.061
dimensions, length x width (cm)	200 x 65	200 x 65
number of cushioned segments	5	6
3-part head bolster	yes	yes
mouth opening in bolster with cover	yes	yes
head end adjustable by gas strut	yes	yes
drainage position adjustable by actuator	yes	yes
leg position adjustable by gas strut	yes	yes
electric height adjustment (cm)	50 - 105	50 -100
manually adjustable height	yes	yes
price	1.800 €	1.900 €

This product line is equipped with a second actuator for adjusting the bed to the drainage position for special physiotherapy. Bed positions can be easily and silently adjusted during therapy.

This product line has a broad area of application. The couches can be used for examinations, massages; they are highly suitable physiotherapeutic treatment for which they are specially designed. In addition they can be used for simple surgical procedures.

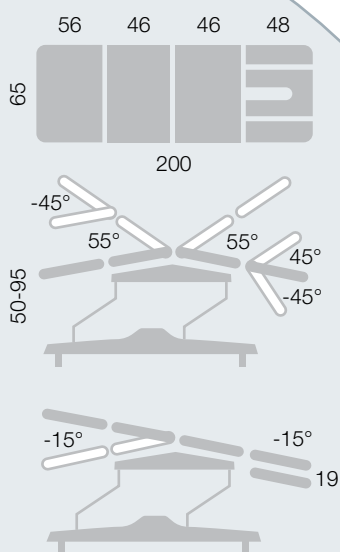

JORDAN
G6
plus

new design
FACE



OPTIONAL ACCESSORIES:

Cat. no.	name	G5e	G6 plus	price
1901.001	castors - diameter 70 mm	•	•	100 €
1901.002	castors - diameter 100 mm	•	-	160 €
1901.006	conical narrowing at the foot end	•	-	50 €
1901.008	electric foot control unit	•	•	50 €
1901.009	RAL electric built-in control unit	•	•	100 €
1901.010	chrome electric built-in control unit	•	•	160 €
1901.013	extended bed width over 80 cm inclusive	•	-	50 €
1901.014	sanitary paper holder behind head end	•	•	50 €
1901.018	additional folding rests along the central part of the couch	•	-	120 €
1901.050	safety switch-off cabinet	•	•	60 €

• extra orders possible - not available

JORDAN physiotherapeutic couch, E line

ORDAN E line -single-actuator couch with electric height adjustment, specially designed for the Vojta method.

The basic design for Vojta method offers a single-actuator bed with electric height adjustment. The construction is stable in all therapeutic positions and heights with a lifting range from 50 to 105 cm even with the patient lying on the bed. **At your request, we can reduce the minimum height of 33 cm. Stroke is then in the range of 33 to 85 cm.** The standard bed width is 100 cm, but you can extend it from 80 to 120 cm. Beds are used in particular in welfare centres for children, physiotherapeutic centres specializing in the Vojta method as well as in households for home exercises with child patients.

We also manufacture a simpler actuator-free JORDAN E folding box couch with fixed height for the Vojta method. The bed is delivered in a standard 100 cm width. You can specify the required height in the purchase order.

The mobile JORDAN E box is an ideal solution for smaller premises – apartments and multi-purpose rooms.



JORDAN
E1e

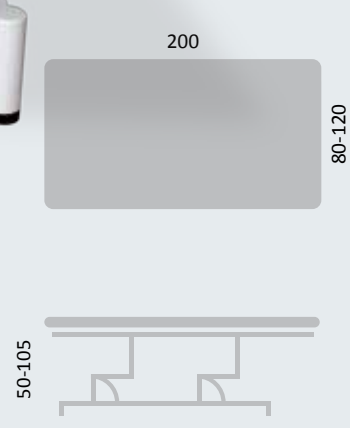

TECHNICAL PARAMETERS

Basic design of the JORDAN E line of couches	E1e	E1e LOW
Cat. no.	1005.011	1005.013
dimensions, length x standard width (width as required 80 - 120 cm)	200 x 100	200 x 100
number of cushioned segments	1	1
electric height adjustment (cm)	50 - 105	33 - 85
manually adjustable height	yes	yes
price	1.350 €	1.400 €



manually adjustable height



castors – diameter 100 mm

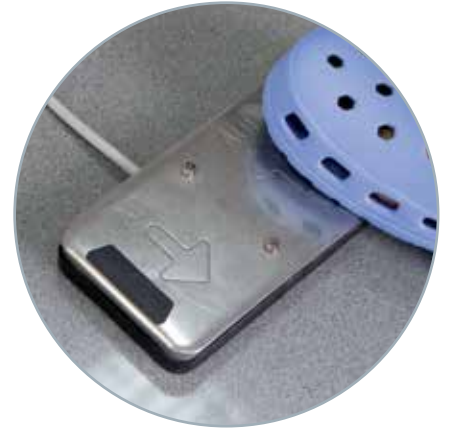

electric foot control unit



JORDAN
E1e
LOW

OPTIONAL ACCESSORIES:

Cat. no.	name	E1e	E1e LOW	price
1901.001	castors - diameter 70 mm	•	•	100 €
1901.002	castors - diameter 100 mm	•	•	160 €
1901.011	mouth opening with cover	-	•	50 €
1901.008	electric foot control unit	•	•	100 €
1901.009	RAL electric built-in control unit	•	-	100 €
1901.010	chrome electric built-in control unit	•	-	160 €
1901.050	safety switch-off cabinet	•	•	100 €

• extra orders possible - not available

JORDAN hospital couches

JORDAN A transport

Acuator-free transport couch (stretcher) with a fixed bed height. Suitable for transport of patients.

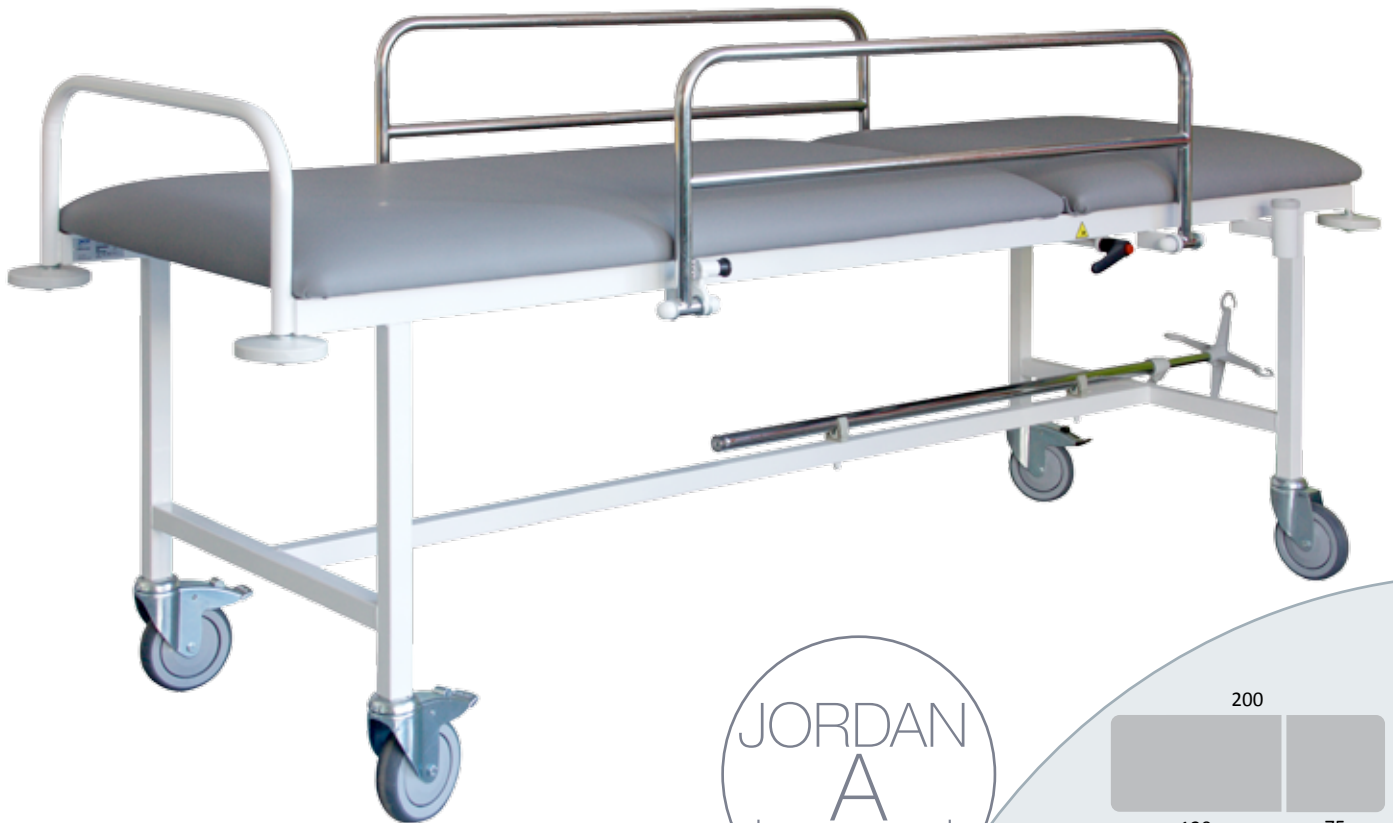

JORDAN
A
transport

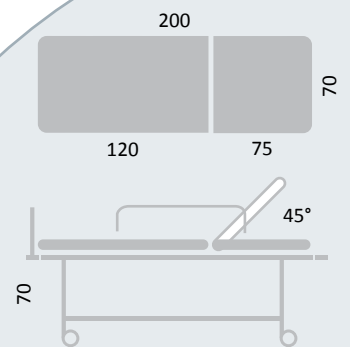

TECHNICAL PARAMETERS

Basic design of the JORDAN hospital couches	A transport	A2h
Cat. no.	1001.050	1001.060
dimensions, length x width (cm)	195 x 65	200 x 70
external length x clearance width	205 x 72	207 x 77
number of cushioned segments	2	2
height adjustment lever hydraulic foot (cm)	-	59 -94
fixed height, alteration at no extra charge (cm)	70	-
head end adjustable by a system of tightening levers	yes	-
backrest adjustable by gas strut	-	yes (2pc)
ø 125 mm castors with possibility of blocking the left front	-	yes
central castor control	-	yes
ø 150 mm castors, full brakes, 1pc of straight direction blocking	yes	-
rotating plastic bumpers	yes	-
bumper castors - diameter 70 mm	-	yes
price	580 €	1.290 €

JORDAN A2h

Transport chair with two-part adjustable hydraulic foot lever.
Suitable for hospitals to transport patients.

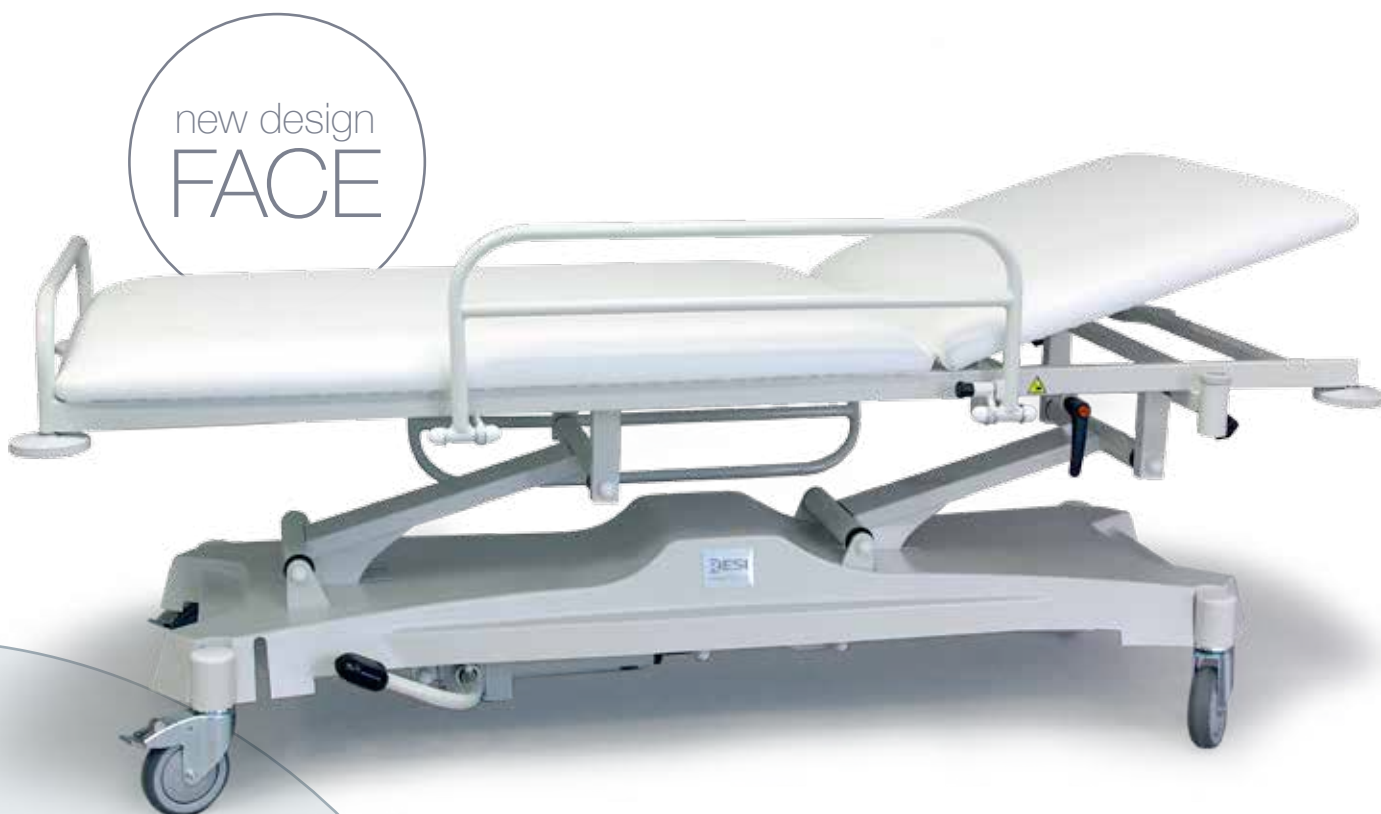

JORDAN
A2h

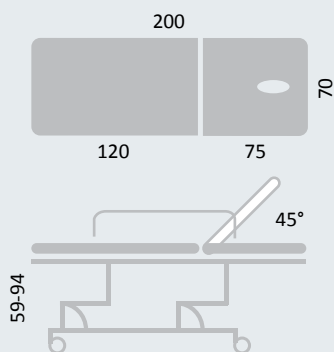

OPTIONAL ACCESSORIES:

Cat. no.	name	A transport	A2h	price
1901.009	RAL electric built-in control unit	-	•	100 €
1901.010	chrome electric built-in control unit	-	•	160 €
1901.014	sanitary paper holder behind head end	•	•	50 €
1901.026	foldable side bars	•	•	100 €
1901.025	infusion stand and stand holder	•	•	100 €
1901.050	safety switch-off cabinet	-	•	100 €

• extra orders possible - not available

JORDAN transfusion couch

JORDAN T3

Single-actuator transfusion couch with electric height adjustment.



JORDAN
T3

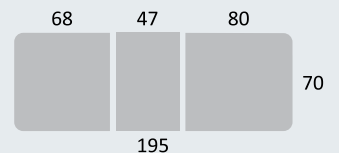

TECHNICAL PARAMETERS

Basic design of the JORDAN transfusion couch	T3
Cat. no.	1020.031
dimensions, length x width (cm)	195 x70
number of cushioned segments	3
electric height adjustment (cm)	65 - 95
manually adjustable height	yes
backrest adjustable by actuator	yes
leg position adjustable by actuator	yes
removable arm rests	yes
price	1.890 €

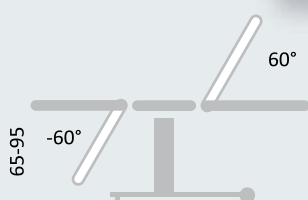

OPTIONAL ACCESSORIES:

Cat. no.	name	T3	price
1901.045	electric foot control unit	•	50 €
1901.014	sanitary paper holder behind head end	•	50 €
1901.025	infusion stand and stand holder	•	100 €
1901.046	auxiliary ascending step	•	150 €

• extra orders possible - not available

JORDAN gynecologic couch, H line

JORDAN H23e - electrically operated gynecologic chair combined with coach.

Height positioning can be carried out even at full loading of the table in range 65 cm – 95 cm with the use of a manual or foot (extra charge) operated electric motor control. The seat tilt setting is electric in range from -10° to 40°. Adjustable removable handles are located on both sides of the seating part. A sanitary paper rack is attached to the backrest. The backrest tilt setting is also electrically controlled in range from -10° to 65°.

In basic version, the chair is supplied with chromed footstalls. For extra charge it is possible to supply calf supports of washable foam

polyurethan with a special joint by means of which the supports can be tilted and fixed according to requirements. A stainless steel vessel is located under the seat. When the vessel is removed, it is possible to attach third part of coach (for extra charge) for lying position of a patient. The chair can be equipped with a tilting step for comfortable seating (for extra charge).

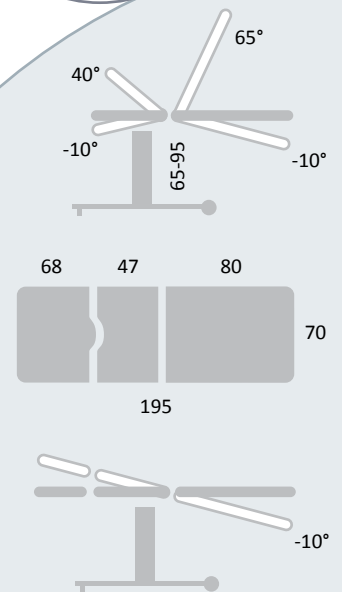

TECHNICAL PARAMETERS

Basic design of the JORDAN H	H23e	H3e
Cat. no.	1008.032	1008.031
dimensions, length x width (cm)	195 x 70	200 x 65
electric height adjustment (cm)	65 - 95	55 - 98
electrically adjustable seating and backrest parts	yes	yes
electric motor manual control	yes	yes
chromed footstalls	yes	yes
sanitary bowl	yes	yes
paper rack	yes	yes
removable handles	yes	-
adjustable head support	yes	yes
Trendelenburg position	yes	-
price	2.600 €	1.695 €

JORDAN H3e - universal coach combined with gynecologic chair.

Coach with electrically controlled height adjustment from 55 cm to 98 cm in combination with a gynecologic chair, suitable for gynecological as well as urological surgeries. Height positioning can be carried out even at full loading with the use of a manual or foot operated (extra charge) or structurally operated (for extra charge) electric motor control. Backrest tilt setting is mechanical and enables easy adjustment from both sides in range from 0° to 75°. Sanitary paper rack is attached to the backrest. The seat is mechanically adjustable in range from 0° to 45° with the use of a gas spring.

In basic version, the table is supplied with chromed footstalls. For extra charge it is possible to supply calf supports of washable foam polyurethan with a special joint by means of which the supports can be tilted and fixed according to requirements. A stainless steel vessel is located under the seat. For extra charge it is possible to equip the table with wheels.

JORDAN
H3e

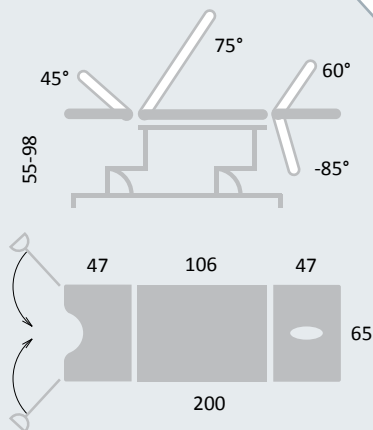

OPTIONAL ACCESSORIES:

Cat. no.	name	H23e	H3e	price
1901.001	wheels ø 70 mm	-	•	100 €
1901.002	wheels ø 100 mm	-	•	160 €
1901.043	fixing joint for euro bar, stainless steel, tilting, universal	•	-	240 €
1901.033	holder for colposcope from a selected manufacturer	•	•	65 €
1901.034	calf supports without point	•	•	190 €
1901.035	calf supports with joint	•	•	85 €
1901.008	foot operated electric control 1 pc on choice (backrest, seat or height adjustment control)	•	-	90 €
1901.046	auxiliary footstand	•	-	70 €
1901.055	removable foot segment	•	-	100 €

• extra orders possible - not available

JORDAN wood

Our professional model JORDAN HENRY is made of ash tree wood.

Beside his technical details, JORDAN HENRY distinguishes by its beautiful design. Our top model is produced in traditional technics of joiner's handicraft in cooperation with masseurs and therapists and guarantees long life even at strongest demands. Wood as base material especially for massage tables offers many advantages:

It does not absorb any rays and creates a feeling of comfort for the customer due to its exceptional look. Best imitation leather materials and a 4 cm thick layer guarantee an optimal comfort.

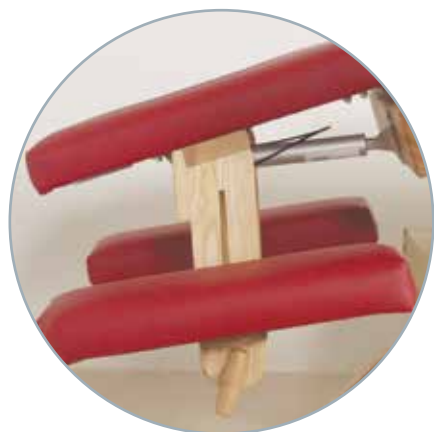

JORDAN
HENRY

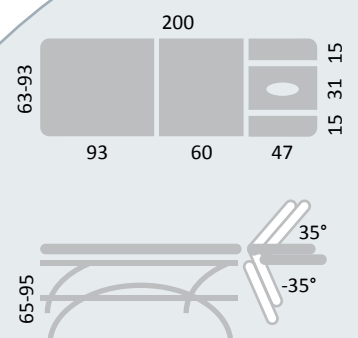

TECHNICAL PARAMETERS

Basic design of the JORDAN wood	HENRY	MARY
Cat. no.	1800.009	1800.019
dimensions, length x width (cm)	200 x 63-93	206 x 65-93
electric height adjustment (cm)	65 - 95	70 - 80
3-part head bolster	yes	yes
thickness of imitation leather (cm)	4	4
Weight (kg)	80	80
price	2.700 €	2.900 €

Elegance, highest lying comfort and stability combined in one massage table has just one name: JORDAN MARY.

Beside his technical details, JORDAN HENRY distinguishes by its beautiful design. Our top model is produced in traditional technics of joiner's handicraft in cooperation with masseurs and therapists and guarantees long life even at strongest demands. Wood as base material especially for massage tables offers many advantages:

It does not absorb any rays and creates a feeling of comfort for the customer due to its exceptional look. Best imitation leather materials and a 4 cm thick layer guarantee an optimal comfort.



JORDAN
MARY

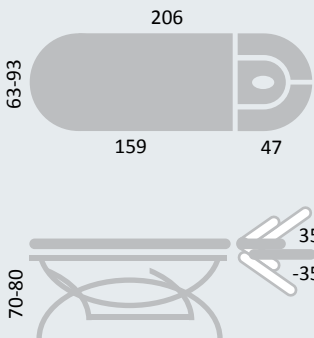

OPTIONAL ACCESSORIES:

Cat. no.	name	HENRY	MARY	price
1901.064	second foot pedal	•	•	100 €
1901.066	thickness of imitation leather 6 cm	•	-	190 €

• extra orders possible - not available

Optional accessories for JORDAN couches



castors – diameter 70 mm



castors – diameter 100 mm



manually adjustable height

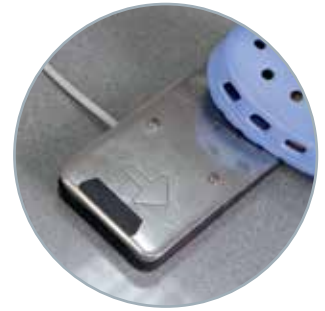

electric foot control unit



castor with brake



safety switch-off cabinet



electric built-in control unit



sanitary paper holder

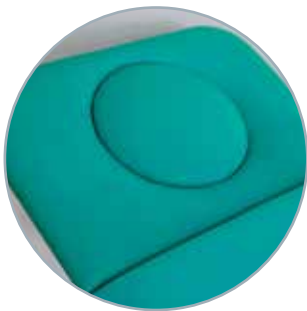

Options of mouth openings with cover



Options of mouth openings with cover

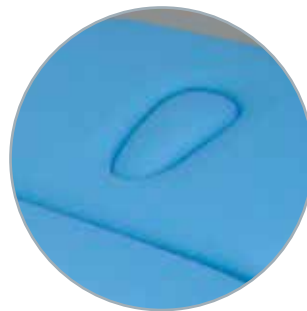

Options of mouth openings with cover



Options of mouth openings with cover



3-part head bolster

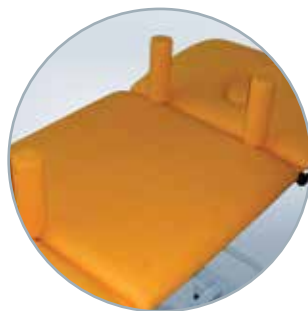

fixation pins - shoulder, between legs

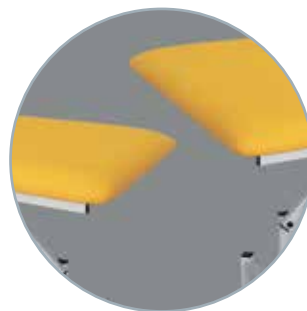

extended bed width



conical narrowing



additional folding rests



infusion stand



foldable side bars



Rostomat system

Colours chart for JORDAN couches

Choose the colour which will best suit your workplace because colours have the power to affect your moods and feelings.

Opt for the yellow of the sunlight, brighten up your office with a sky-blue table; let the green upholstery enhance the peaceful atmosphere or relax by a pure white table.

Let your imagination decide.

Leatherette upholstery sampler



OS



10S



14



16

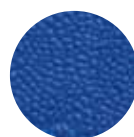

18S



2



26

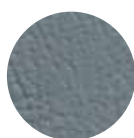

30



34S



37S

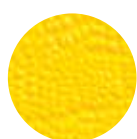

3S

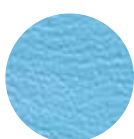

40

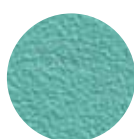

56036



56039



56048



56051

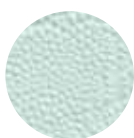

5S

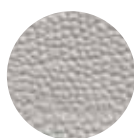

7S

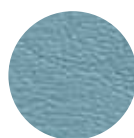

8



9

Construction frame RAL colour sampler

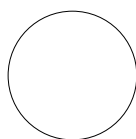

9003

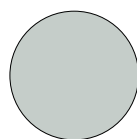

9006

The pictures, text, and colours in the catalogue are approximate and are not binding.
The products can be changed without prior notice.

Prices of tables and their accessories are stated without the 21% VAT



RESI Třeboň spol. s r. o.
Novohradská 1153
379 01 Třeboň, Czech Republic
Tel.: +420 384 724 292
Fax: +420 384 724 293